

GEMCO VALVE

12" 'P21' Valve

January 2014

Size: A

Scale 1:8

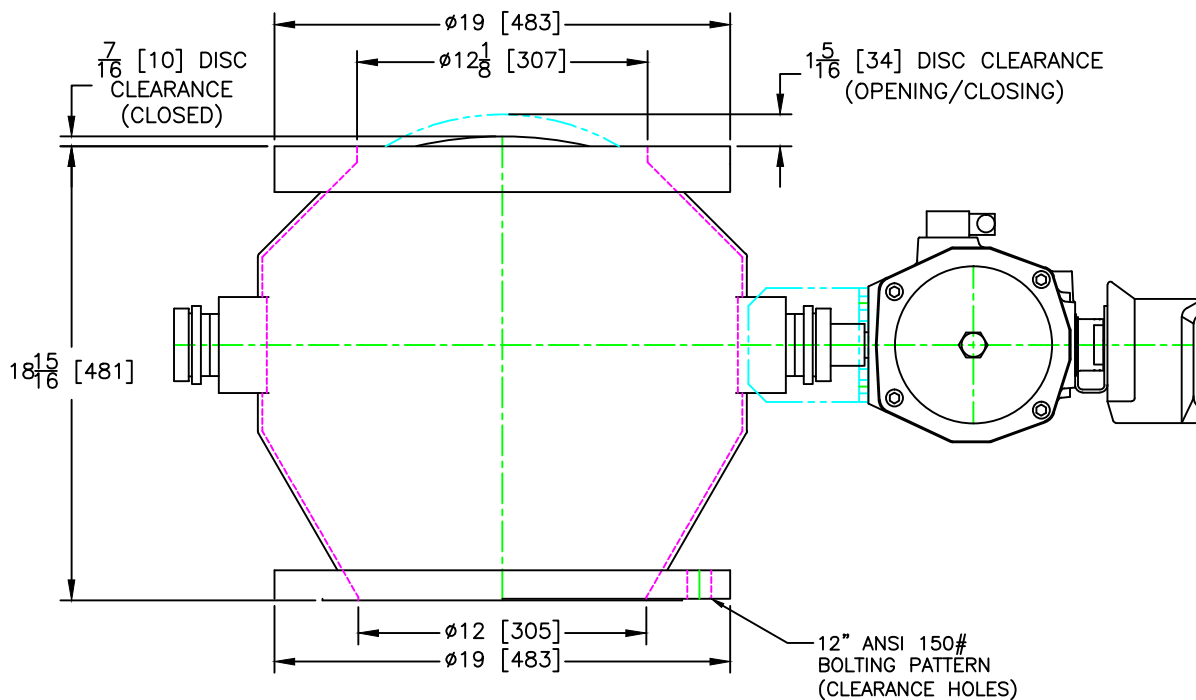
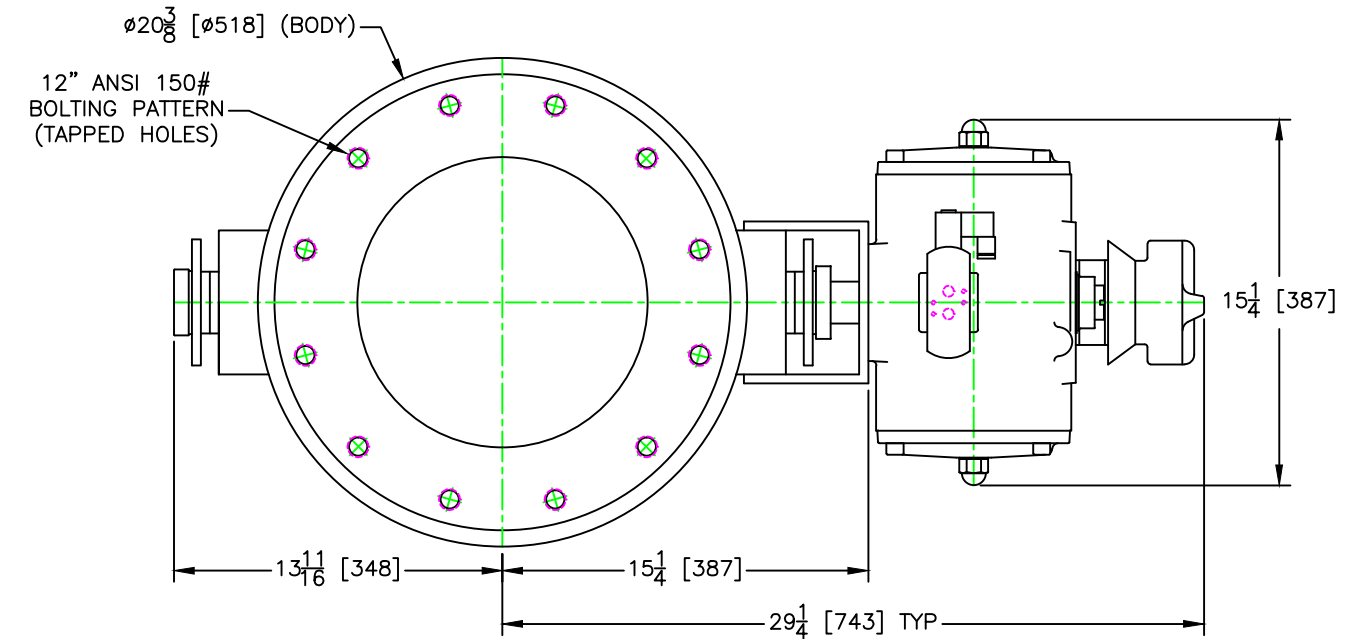

APPROXIMATE WEIGHT: 350 lbs / 160 kg